

## MTD100 MAGNETIC TRANSITION DETECTION COIL

The MTD100 coils are a pair of radially stacked copper coils designed to detect gross changes in the magnetic susceptibility of a sample while it is being strained in a Razorbill Instruments stress or strain cell. Such measurements may be preferred over electrical transport, as they do not need contacts to be attached to the sample.

The MTD100 coils are designed to measure the temperature of transitions such as superconductivity which involve large susceptibility changes. The geometry of the coils and their generic nature mean they are not suitable for accurate measurement of susceptibility. They may be suitable for tracking other types of transition, or for de Haas – van Alphen measurements, depending on the material.

# SPECIFICATIONS

<b>Physical Specifications</b>			
Diameter		0.75	mm
Thickness		0.5	mm
Lead Length		4	mm
Tinned Lead Length		2	mm
Lead diameter		20	μm
<b>Electrical Specifications</b>			
Resistance, Transmit Coil	At room temperature	7.5	Ω
	At 4 K	90	mΩ
Inductance, Transmit Coil		7	μH
Resistance, Receive Coil	At room temperature	16	Ω
	At 4 K	200	mΩ
Inductance, Receive Coil		14	μH
Capacitance, Between Coils		12	pF
Design Current		5	mA <sub>RMS</sub>
Absolute Maximum Current		20	mA <sub>RMS</sub>
Design Frequency		3	KHz
Design Power Dissipation <sup>1</sup>	At room temperature	190	μW
	At 4 K	2.3	μW
Typical output signal size <sup>1</sup>		1	mV <sub>RMS</sub>
Typical change in signal at onset of superconductivity <sup>1</sup>		0.08	mV <sub>RMS</sub>
<b>Environment</b>			
Atmosphere	Vacuum, air, or exchange gas such as helium		
Maximum Temperature	Storage and operation	100	°C



<sup>1</sup> At 3 KHz, with 5 mA RMS excitation current

# REFERENCE IMAGES AND DIMENSIONS

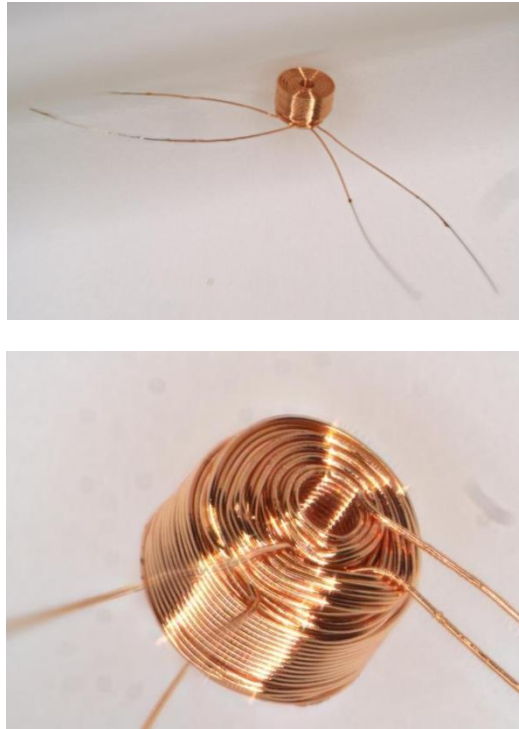

Figure 1 - Photomicroscope images of a typical MTD100

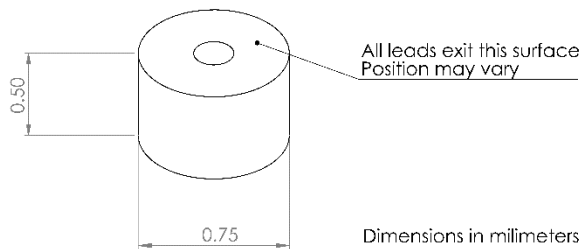

Figure 2 - Dimensions

# PRINCIPAL OF OPERATION

The MTD100 consists of two coupled inductors. If one is excited with a fixed AC current, a voltage may be measured in the other. When placed adjacent to a sample of material, the susceptibility of that material affects the strength of the coupling.

The strength of the coupling will also be affected by changes in geometry of the coils due to thermal expansion, and by changes in the geometry of the sample due to thermal expansion and applied strain. These confounding influences may exceed the influence of the susceptibility of the sample. The coils are therefore unsuitable for accurately measuring the susceptibility of the sample, but they are suitable for detecting abrupt changes in susceptibility, such as the onset of superconductivity or transition between paramagnetism and ferromagnetism. They are also suitable for detecting the frequency of de Haas – van Alphen oscillations in susceptibility, provided that the measurements electronics can recover the signal with sufficient resolution at the required frequency.

A typical result, showing the superconducting transition in tin-lead solder, is shown in Figure 3.

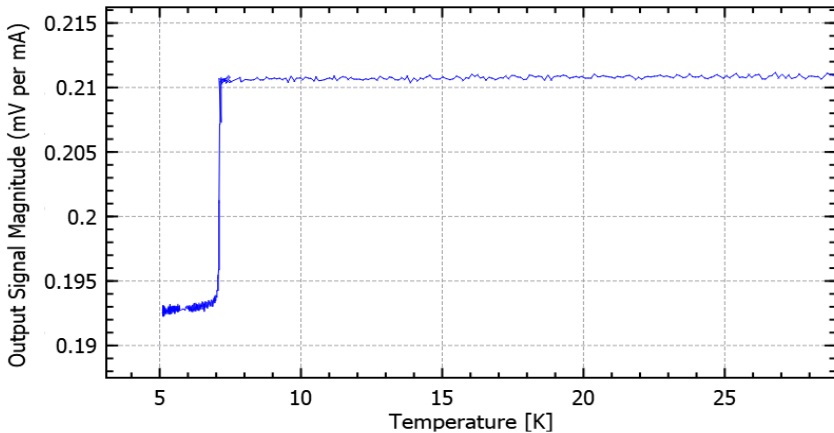
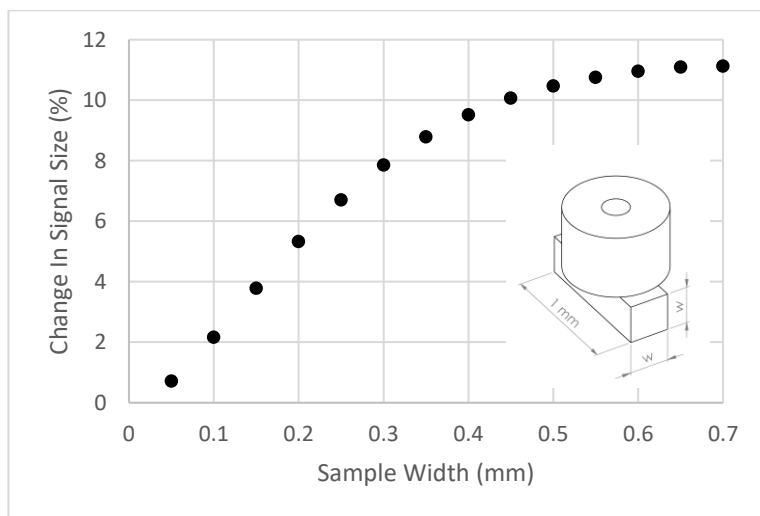

**Figure 3 - variation in magnitude of output voltage with temperature, showing abrupt change at 7 K as the tin-lead sample becomes superconducting.**

## Mounting and Sample Geometry

The MTD100 should be attached adjacent to the sample, either by bonding it directly to the sample or by bonding it to a piece of Kapton film or other material sprung against the sample. In the latter case, the material must be selected to avoid any transitions in magnetic properties, as these will be detected by the MTD100 and not to screen the sample at the frequency of operation.

The MTD100 should be oriented so that the flat surface is against the specimen and the centreline of the specimen is aligned with the centre of the coil. It is acceptable for the sample to be narrower than the diameter of the coil, but if the sample is too small the change in signal size at onset of superconductivity may be too small to detect. Figure 4 shows calculated signal size changes for square rods placed adjacent to the flat face of the MTD100.



**Figure 4 - Plot of change in output signal at onset of superconductivity against sample size. Based on numerical simulation of a square-section 1 mm long rod adjacent to the flat side of the MTD100 undergoing a change in volume susceptibility  $\Delta\chi = 1$**

At the end of the experiment, the MTD100 can be removed and re-used for a small number of experiments. If heating to remove an adhesive, do not exceed the maximum temperature shown in the

specification table, or the adhesive used in manufacturing the coil may soften. The MTD100 has a poor resistance to polar solvents, so they should not be used.

## MEASUREMENT ELECTRONICS

### Hardware Requirements

Two aspects are required: a clean sinusoidal excitation signal, and measurement of a small AC voltage signal. The small size of the output signal lends itself to measurement with a lock-in amplifier. Lock in amplifiers often include a suitable sine source for excitation.

If the device providing the excitation signal generates a voltage rather than a current, a large series resistor should be used. This prevents the current rising as the resistance of the MTD100 transmit coil falls with declining temperature. For example, if a lock-in amplifier with a built in 5 V ac source is used, the source should be connected to the coil in series with a 1 K $\Omega$  resistor, which will limit the current to 5 mA. A suitable arrangement is shown in Figure 5.

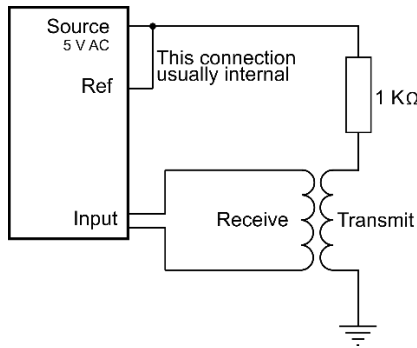

**Figure 5 - Recommended connections for a lock-in amplifier with built in voltage source**

An alternative approach to measurement is to use an LCR meter. For example, the Keysight E4980AL which Razorbill Instruments recommends for measuring our capacitive displacement sensors is suitable. In this case the LCR should be configured to use constant

current excitation, which is applied to the transmit coil. The receive coil is then attached to the voltage terminals as shown in Figure 6.

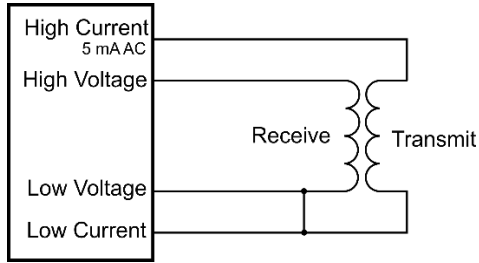

**Figure 6 - Recommended connections for an LCR meter (such as the Keysight E4980AL) configured for constant-current excitation. It is necessary to link the low terminals together for the Auto-Balancing Bridge aspect of the meter to function correctly.**

Measurements are also possible with more general-purpose instruments. For example, Razorbill Instruments initially tested the MTD100 using the headphone output of a desktop PC as a waveform generator, with a USB oscilloscope to capture both the excitation and the returned signal. The captured waveforms were subsequently demodulated in software.

### Choice of Frequency

Higher frequency excitation of the transmit coil improves the size of the output signal but places more demands on wiring. At frequencies above 10 KHz, we find that the output signal shows some dependence on temperature. This is presumed due to the reducing resistance of the coils with declining temperature. This effect may vary according to the measurement electronics used, and their ability to accurately measure the magnitude of the output signal independently of its phase. For some measurement methods, the length and resistance of the wiring through the cryostat may also be relevant. For simplicity, we recommend not using a frequency much higher than that needed to get a good signal, and suggest 3 KHz as a suitable starting point. If in doubt, we recommend testing the coil in your cryostat with the proposed wiring and measurement instruments but no sample, so that a background performance may be obtained.

## Choice of Current

Choice of amplitude for the excitation signal is merely a matter of balancing signal size against power dissipation. 5 mA was chosen as the reference level for all other figures in this document and corresponds to a dissipation of approximately  $2.3 \mu\text{W}$  at 4 K. This level may need to be adjusted according to the conditions of your cryostat.



**Do not exceeded the absolute maximum current rating or the adhesive used in manufacturing the coil may fail**

(See specification table for absolute maximum current rating)

Some of the heat generated by the MTD100 will be conducted away by its leads, but much of the heat may be transferred to the sample. The amount of heat that can be tolerated may depend on the quality of heat sinking of the sample, including any exchange gas.

## ELECTRICAL CONNECTIONS

The MTD100 has 4 leads, they can be identified as follows:

- The inner coil has two leads, one from the inner layer and one from the middle layer
- The outer coil has two leads, one from the middle layer, and one from the outer layer
- The inner coil has a lower resistance than the outer coil
- Due to the lower resistance, we recommend the inner coil is used as the transmit coil, and the outer as receive. This will minimise power dissipation for a given current

Inverting the leads of either coil does not affect the quality of measurement but does introduce a  $180^\circ$  phase shift.

The MTD100 is provided with tinned leads which are freely solderable. If it is necessary to shorten the leads, the insulation may be stripped by brief immersion in a droplet of solder at higher temperature than normally required for soldering. We recommend that temperature be



increased cautiously, as excessive time and temperature will dissolve the wire into the solder.

The Razorbill Instruments WP100 Wiring Platform provides a suitable transition to larger wiring and includes a heat sink. If a standard WP100 is used, the connections shown in Figure 7 are recommended.

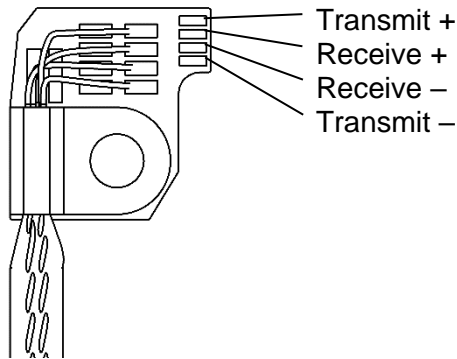

**Figure 7 - recommended connections when using a WP100 wiring platform**

In some cases, it may improve signal to noise ratio to reduce loop area where the wires from the coil join the twisted pairs on the wiring platform. In that case, one can change the wires on the platform for a T+ T- R+ R- arrangement by resoldering them. Razorbill can also provide WP100s configured this way on request.

# MTD100 MAGNETIC TRANSITION DETECTION COIL

